

Contemporary Series

LUXAFLEX® Evo Range

Product: LUXAFLEX® Evo Side Tensioned Channel (STC) Awning.
Fabric: Everscreen Schist.

LUXAFLEX®

WINDOW FASHIONS



CONTEMPORARY SERIES

LUXAFLEX® Evo Awning Range

CONTEMPORARY SERIES OVERVIEW

The LUXAFLEX® Contemporary Series represents the latest in Awning design, styling and quality. Developed to meet market demand for a modern and contemporary hardware system suited to the newest architectural design trends. Featuring a variety of hardware choices, including Folding Arm Awnings, Cable Guides, Side Tension Channel (STC) and a Pivot Arm Awning, you can select the perfect product for your personal external shading requirements, whilst maintaining a commonality of appearance and design.

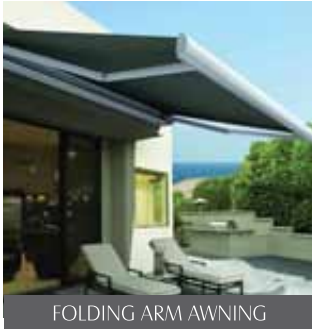

FOLDING ARM AWNING



CABLE GUIDE



SIDE TENSION CHANNEL



PIVOT ARM

CONTEMPORARY SERIES - EVO AWNING RANGE

The LUXAFLEX® Evo Awning Range is the latest addition to the popular Contemporary Series. It was locally developed to bring the latest in design, styling and quality to the Australian market.

DESIGN

The universal Headbox System has been intelligently designed to incorporate a variety of side guiding options for flexibility and functionality, whilst maintaining a consistent design.

The Evo Awning Range can also be used without a Headbox providing a contemporary entry level option.

STYLING

The Headbox and Bottom Rail incorporate a subtle curve to enhance the aesthetics and co-ordinate with modern housing trends. This gives a unique classic style to each of the Evo Awning Range of products making it a perfect addition to any home design.

QUALITY

The componentry is designed and engineered in Australia specifically for the Australian market, making it ideal for our unique climate conditions. The system is manufactured in Australia using strict quality control and inspection processes to ensure the product exceeds consumers' expectations. Backed by a LUXAFLEX® 5 year warranty*, customers can have peace of mind on the longevity of their external shading solution.

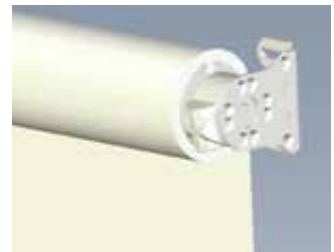

AUSTRALIAN MADE

CONTEMPORARY SERIES

LUXAFLEX® Evo Awning Range

FEATURES & BENEFITS

The new Evo Awning Range shares a number of benefits across all guiding options.

These include:

- Designed for large spans
- Headbox & Open Roller options
- Multi-Function Bottom Rail
- Variety of Operating Options
- Versatile and flexible installation
- Colour co-ordination & multiple fabric options

DESIGNED FOR LARGE SPANS

Modern design is trending towards larger windows, thereby demanding wider shading solutions. The Evo Awning Range is capable of widths up to 5 metres and drops up to 4 metres by incorporating a heavy duty 78mm steel roller tube.



HEADBOX & OPEN ROLLER OPTIONS

The optional Headbox encloses the fabric and protects it from external elements such as rain, UV and debris which assists in keeping the fabric clean and enhances longevity.

Utilising a common Headbox allows consumers to choose guiding systems to suit various applications without changing the product aesthetics.

Each of the awnings in the LUXAFLEX® Evo Awning Range is available with an open fabric roller, offering entry level pricing.

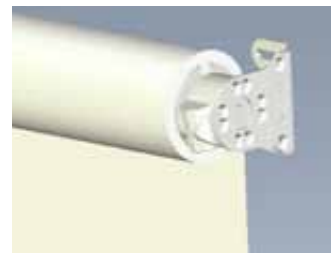

MULTI-FUNCTION BOTTOM RAIL

The multi-function bottom rail has been developed to incorporate modern design, whilst also maximising functionality and weight.

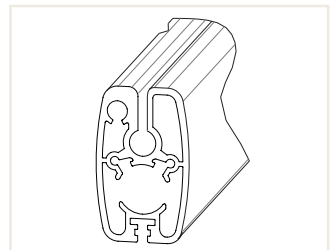

DESIGN

The Bottom Rail design has a slight curve to match the head boxes' subtle classic styling. It maintains seamless aesthetics throughout the Evo Awning Range and provides 5 unique points of difference.

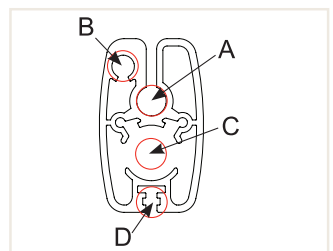

CONTEMPORARY SERIES

LUXAFLEX® Evo Awning Range

FUNCTIONALITY

- A The spline insert has been recessed into the Bottom Rail to cover the fabric join thereby minimising the visibility of any unsightly welding or stitching. This greatly improves the appearance as the fabric disappears into the rail.
- B A sliding bolt system can be incorporated in the Bottom Rail which will allow the awning to be locked into position to hold the fabric taut, and minimise any Bottom Rail movement. This is essential for spring operated Channel Systems.
- C An optional steel rod can be inserted into the Bottom Rail to maximise weight which helps the fabric lay flat. It also reinforces the Bottom Rail ensuring minimal flexing in wide applications. The weight rod utilises a heat shrunk plastic outer cover to minimise noise when the Bottom Rail is moving.
- D The underside of the Bottom Rail incorporates a Channel which provides two functional benefits.
- i – A Polyester Brush can be inserted along the length of the Bottom Rail to minimise light gaps when the Awning is fully lowered to the floor. It also protects the Bottom rail profile if the awning is inadvertently lowered too quickly.
 - ii – A hold down clip can be inserted converting the Awning into a no guide hold down option (Evo Drop Awning). This is great for applications when there is no ability to use guides or when consumers want to utilise the hold down strap option.

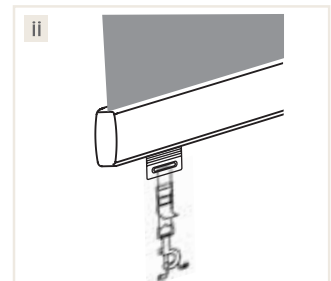
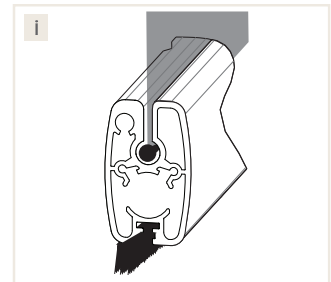
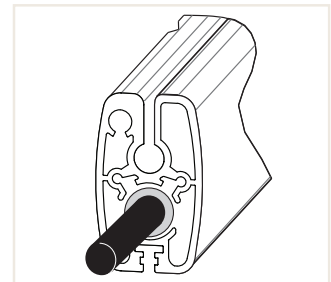
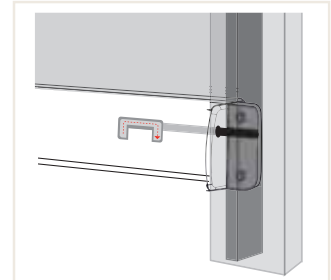
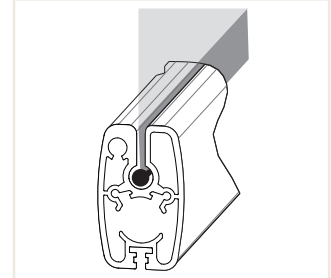

WEIGHT

The robust Bottom Rail has been designed with 2.5mm aluminium walls producing 1.5 kgs of weight per metre. The increased thickness also ensures minimal Bottom Rail flex when used in wider applications. The Bottom Rail, when combined with the optional steel rod insert, can provide an overall weight of up to 2.4kg per metre ensuring minimal bottom rail “bounce” from wind.

CONTEMPORARY SERIES

LUXAFLEX[®] Evo Awning Range

OPERATING OPTIONS

The LUXAFLEX[®] Evo Awning Range of products have been designed to offer maximum flexibility for consumer operation.

MANUAL CRANK

The 9:1 ratio gear ensures easy operation that is not dependant on the user's strength. Specifically designed for straight drop applications the gear features an internal dampener which protects the gearing components in high wind situations.

Available in a selection of Black, Grey and White for improved colour co-ordination.

There is also a great new range of polished zinc crank handles available in: 800mm, 1200mm, 1600mm, 2000mm & 2400mm lengths.

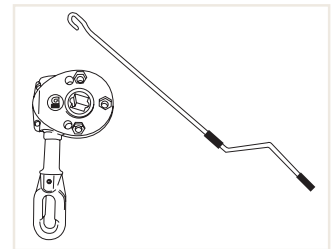

MOTORISATION

A range of external motor solutions allow Awnings to be operated at a touch of a button or via a wall switch control. Also available is the latest Automatic Tensioning Motor that permits the Awning to be locked in position (with strap or sliding bolt) and tensioned. This maintains tension on the fabric minimising fabric "blow outs" traditionally caused by unexpected high winds. Optional accessories include sun and wind sensors, special remotes and integration into home automation systems providing intelligent Awning control.



INTERNAL CORD WINCH

This option provides an entry level price for consumers wanting to operate the Awning from inside their home. (maximum of 3.5metres wide).

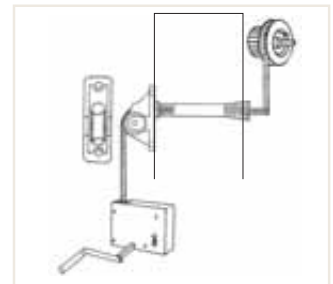

SPRING OPERATION

Allows the Awning to be manually pulled down to the required height and locked off using either the Sliding Bolt System or Hold Down Clip option. (maximum 3.5 metres wide).

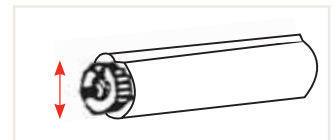

INSTALLATION

The Awning System can be installed in different applications, including face, ceiling, or side fixing.

By using the same universal bracket in both Headbox and open roller configurations, installation is kept simple and consistent. To improve installation flexibility an additional mounting plate is available that can alter the fixing position by up to 250mm.

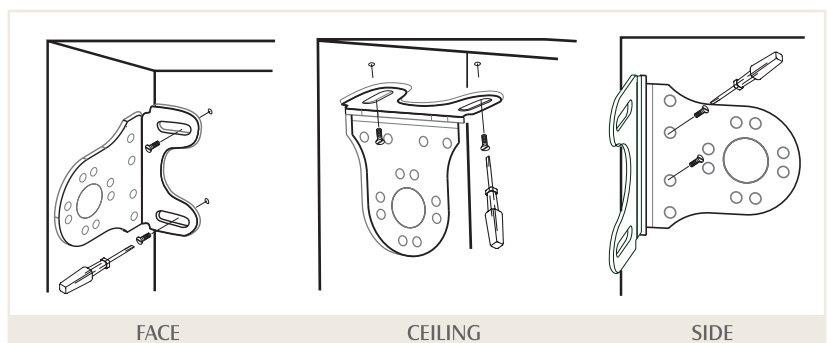

CONTEMPORARY SERIES

LUXAFLEX[®] Evo Awning Range

COLOUR CO-ORDINATION

HARDWARE

The standard hardware colour silver pearl reflects the latest in contemporary external colour trends. Powder coating options allow customised colour coordinating to either fabric or exterior colour schemes.

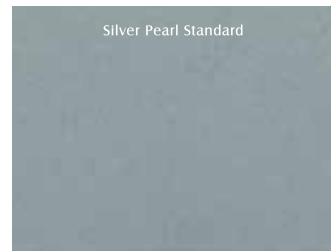

FABRIC OPTIONS

EVERSCREEN EXTERNAL SCREEN - Consumers have a great choice from 24 colours incorporating metallic, natural and clear yarns. With a 10% openness factor this fabric provides significant heat and glare reduction, with ultra violet protection. You can maintain a view whilst allowing a gentle breeze to permeate when the window is open.

Available in 3.2m widths, and incorporating a stable 2 x 2 weave, allows some Evo Awning models to be manufactured up to 5 Metres wide with a 2.9 Metre drop with no unsightly fabric joins.



DICKSON CONSTANT ACRYLIC - With up to 80 colours in the range, consumers have a choice of solid and striped fabrics from which to make their selection. Acrylic fabric provides a semi block out which is great for improved privacy and sun control. 1.2 metre panel widths are standard, with selected colours available in 2 Metre wide panels to minimise the visual effect of joins. Some colours are also available with Dickson Max (1.2m wide) which offers enhanced water proofing and self-cleaning properties (Surcharge applies).



CLEAR PVC - All Crank, Spring, Winch or Motorised Straight Drop Awnings can be ordered with a premium .75mm quality clear PVC. This option provides enclosures with improved protection from wind and wet weather whilst also allowing great view through. (12 month warranty on PVC option).



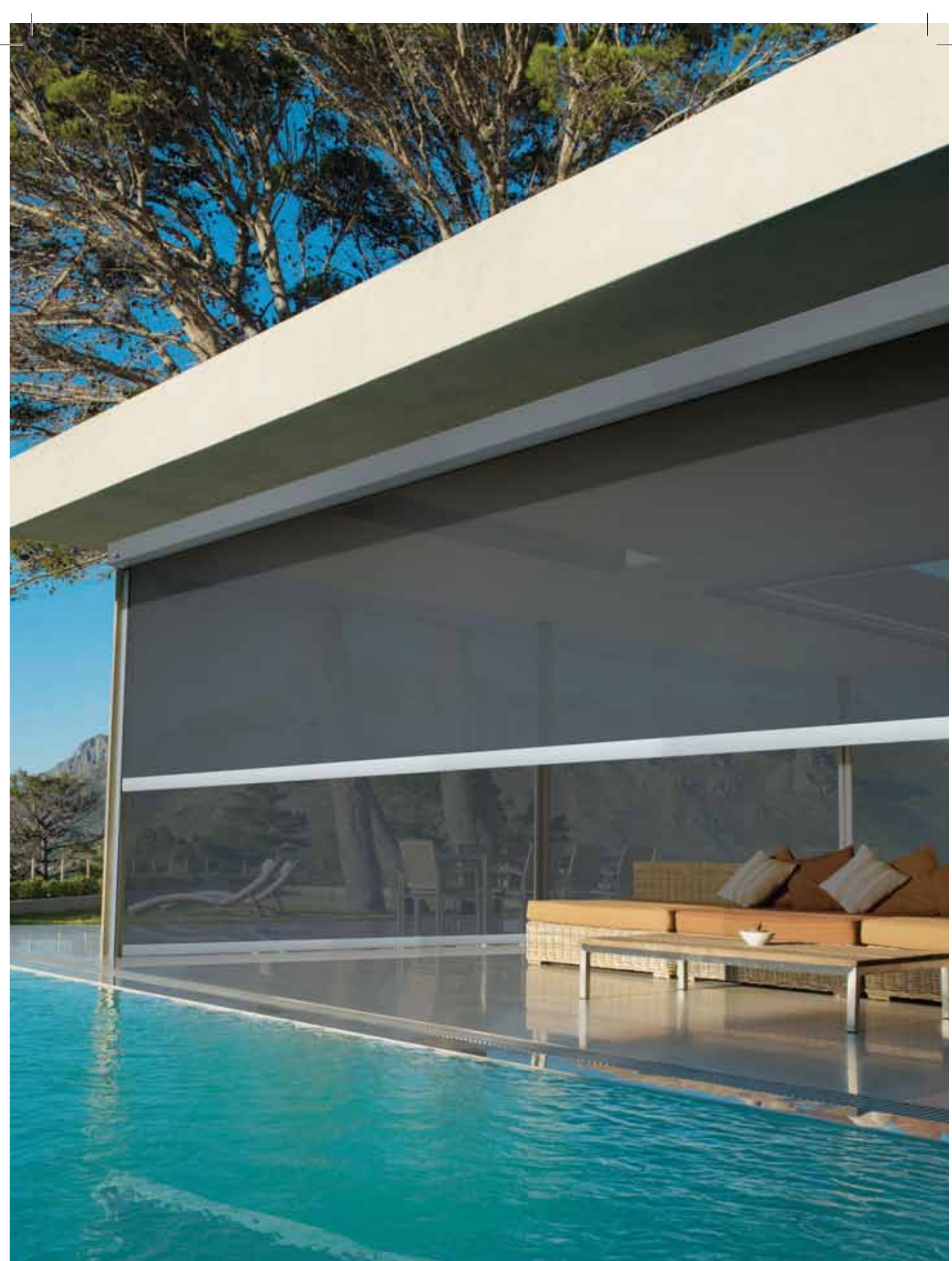

CONTEMPORARY SERIES

LUXAFLEX[®] Evo STC (Side Tensioned Channel) Awning

OVERVIEW

The EVO STC awning is a premium, versatile straight drop option ideal for: sun/UV protection, insect resistance, windy applications, enclosing a balcony plus creating privacy, light and heat control. The fabric is tensioned by utilising a sliding insert, located within the special two piece side channel, eliminating the possibility of fabric "blow outs" or light gaps. As the fabric is held taut between the left and right channels, this system is ideal for enclosing courtyards, patios or balconies, essentially adding an extra room to the home.

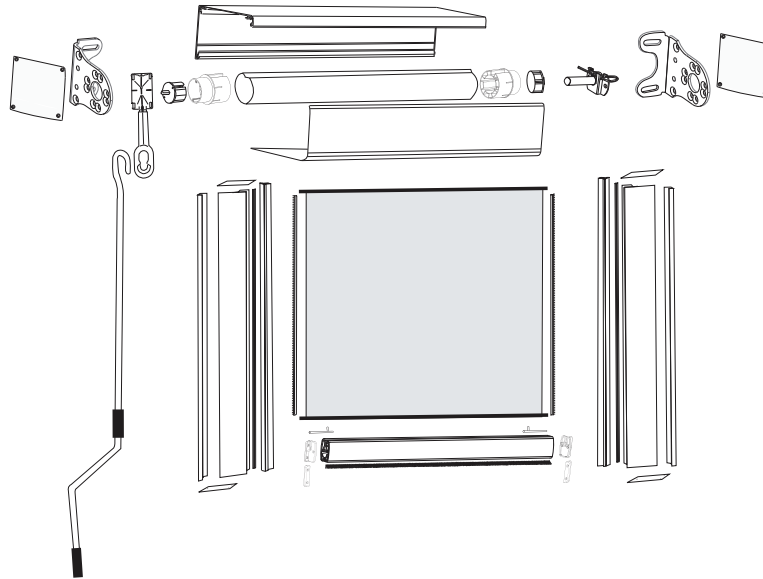

TWO PIECE SIDE CHANNEL

By utilising a common L section channel for fixing (also used in the Evo Channel Awning) we have ensured no visible screws or rivets on the finished install. The front channel simply snaps over the L section to provide a neat, clean finish.

FLEXIBLE INSTALLATION

As the fabric is tensioned in the side channels, accurate measurements for installations would normally be essential. Due to the unique floating insert there will be some installation flexibility with the channel. The insert feature will also move with the wind and take strain off the welds and joins in the fabric. Clever sound bumpers have been incorporated inside the channels to minimise noise when operating or in windy conditions.

TUBE REDUCERS

There is a potential for fabric thickness build up at the end of the roller, as the awning is raised. The use of custom designed tube reducers minimises this build up, thereby ensuring the fabric rolls as symmetrically as possible, whilst the Awning is in operation.

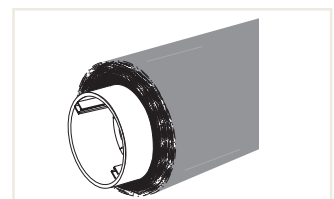
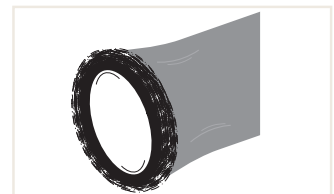
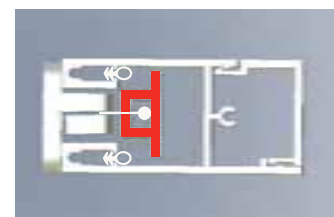
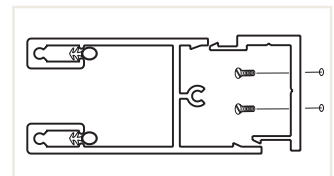



CONTEMPORARY SERIES

LUXAFLEX[®] Evo Cable Awning

OVERVIEW

The Evo Cable Awning is a great contemporary straight drop option for: sun/UV protection, air flow and where channels are not suitable. The cables are high tensile 316 grade marine stainless steel, making them perfect for coastal applications.

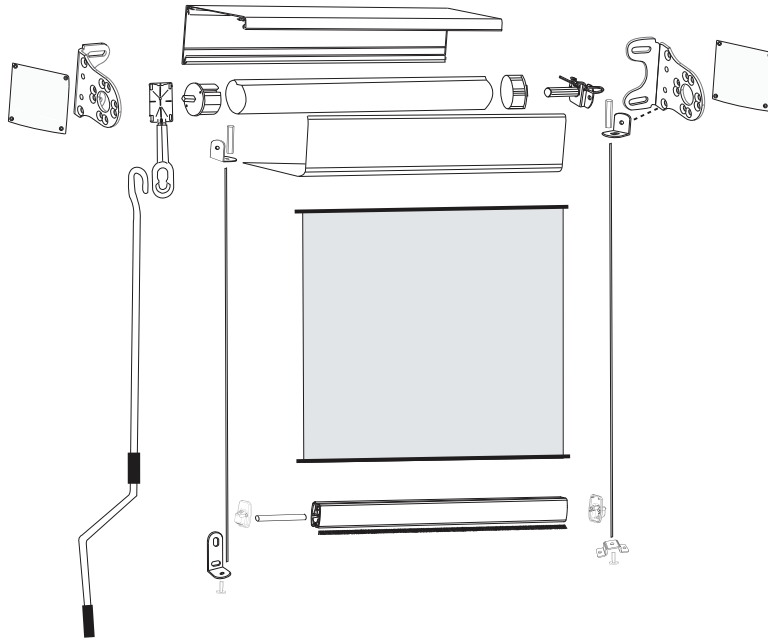

CABLE TENSIONER

The new cable fixing method gives greater flexibility when tensioning the side cables. Firstly, manually pull tension on the cable via the top and bottom lugs. This tension is then held and locked off using grub screws. As necessary, additional tension can then be applied by tightening the nut on the top lug. This option works in all installation applications, with consumers even being able to reapply tension simply by tightening the nut on the top lug.

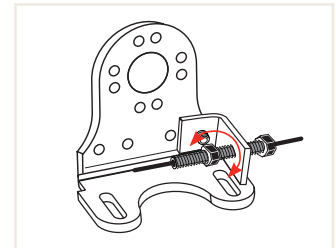

CABLE MOUNTING OPTIONS

Fabricated from modern, polished stainless steel, you have the choice of either floor or wall mount brackets. A 2.5mm thickness ensures the brackets not only look great but give long term durability

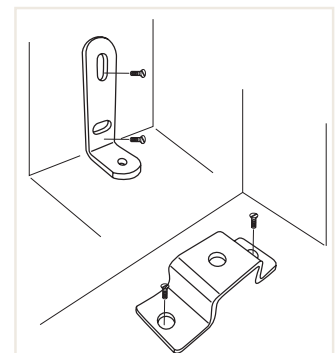

BOTTOM RAIL END CAPS

The Cable System Bottom Rail end caps allow the Bottom Rail to reach the ground when using the floor mount option. When combined with the Bottom Rail Brush Option, this will assist in eliminating light gaps from under the Bottom Rail when fully lowered.

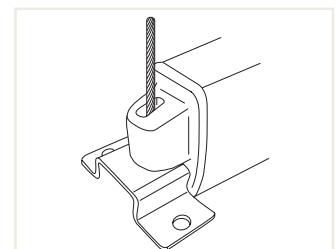

CONTEMPORARY SERIES

LUXAFLEX® Evo Channel Awning

OVERVIEW

The Evo Channel Awning is a great straight drop option for: sun/UV protection, windy applications, plus privacy and block out situations. This option allows up to 30mm of fabric within the channel, therefore eliminating light gaps and reducing the potential for fabric “blow outs” in windy conditions. This is a cost effective alternative to the LUXAFLEX® Evo STC Awning.

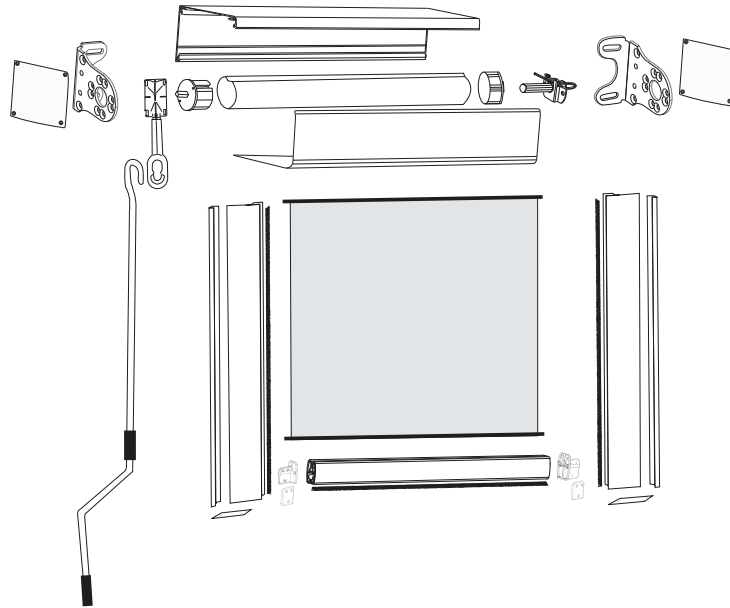

TWO PIECE SIDE CHANNEL

By utilising a common L section channel for fixing (also used in the Evo STC Awning) we have ensured no visible screws or rivets on the finished install. The front channel simply snaps over the L section to provide a neat, clean finish.

BOTTOM RAIL END CAP

The Evo Channel Awning Bottom Rail end cap consists of two pieces designed to clamp the fabric and carry it in the channel. By utilising the end cap for this function (as opposed to the Bottom Rail) we have significantly reduced the depth of the channel making it smaller than most competitor Channel Systems.

SLIDING BOLT

This option allows consumers to secure the Bottom Rail at various heights, by simply sliding the bolt into selected hole positions in the side channel and locking into position. This feature holds the fabric taut and minimises Bottom Rail movement.

This feature is essential for spring operated Channel Systems.

BRUSH

The side channels incorporate a brush insert down the length to assist in retaining fabric within the channel, whilst also minimising noise from movement.

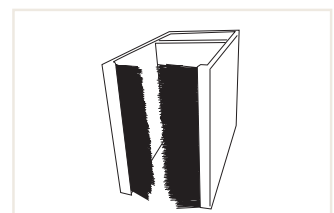
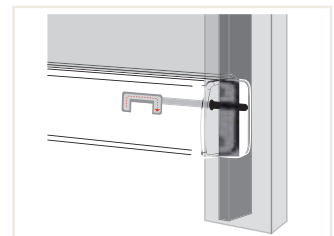
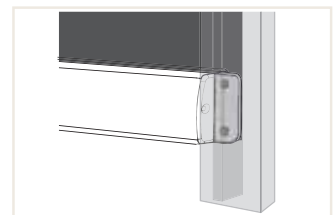
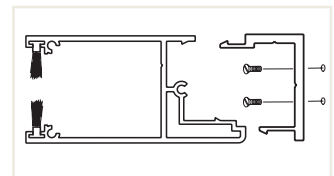

CONTEMPORARY SERIES

LUXAFLEX[®] Evo Pivot Awning

OVERVIEW

The Evo Pivot Awning projects the fabric off the window, with the arms and fabric forming an arc that allows air to flow behind the Awning. This allows windows to be open whilst the Awning is projected. This system is a heavy duty contemporary design ideal for larger windows.

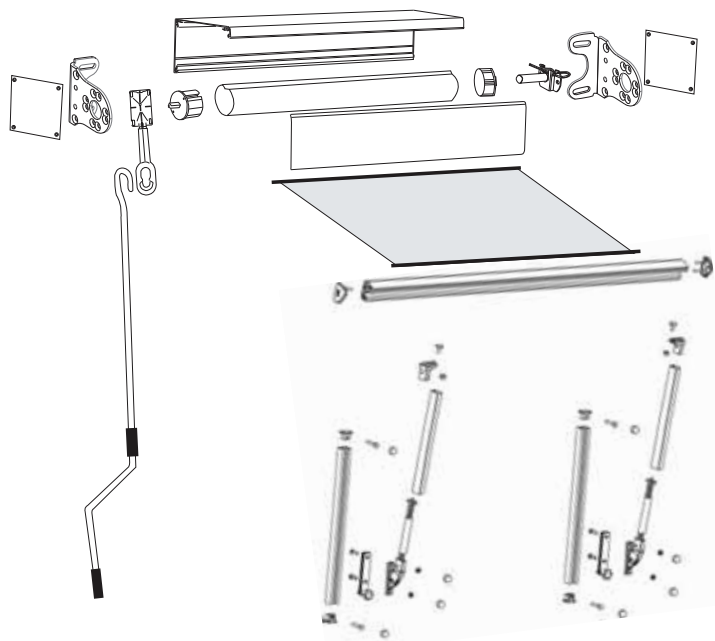

HEADBOX

We have designed a special Headbox that allows the underside of the cassette to be open to accommodate the angle required for effective Pivot Arm operation.



HEAVY DUTY PIVOT ARM

The heavy duty spring incorporated in the Pivot Arms provides excellent fabric tension even with Awning widths up to 5 metres. The arms are a modern anodised finish that complements our standard Silver Pearl hardware.



SLIDING ARM SET





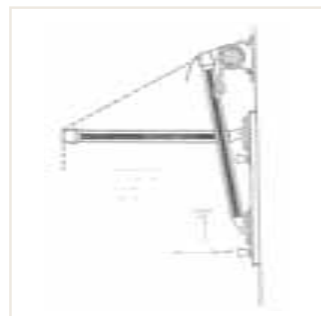





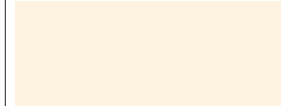
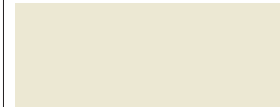



An optional sliding arm set facilitates changing the pivot point of the Awning by simply moving the arms up or down the sliding rails. This allows the Awning to operate like a normal Pivot Arm in the down position, and in the raised position it allows head clearance over doorways providing a canopy effect.

(This option is not available with a Headbox).



CONTEMPORARY SERIES

Powder Coating Colour Card

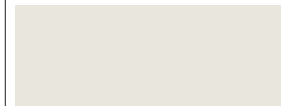
 Precious[®] Silver Pearl 57225 Satin	 White Satin 32312 Satin	 Primrose 84365 Gloss	 Shoji White 84682 Satin
 Stone Beige 32538 Matt	 Anotec[®] XT Off White 51271 Matt	 Rivergum Beige 36991 Gloss	 Pottery 33662 Satin
 New Hammersley Brown 84657 Satin	 Deep Brunswick Green 50068 Gloss	 Navy 50282 Gloss	 Old Pewter 50243 Satin
 Matt Black 19319 Matt	 Anotec[®] XT OSilver Grey 51272 Matt	 APO Grey 32786 Satin	 Notre Dame 36672 Gloss
 Classic Cream[™] 84755 Satin 84732 Matt	 Sandbank[®] 88482 Satin	 Jasper[™] 88479 Satin	 Headland[®] 84761 Satin 84615 Matt
 Manor Red[™] 84752 Satin 52094 Matt	 Paperbark[®] 84212 Satin 51968 Matt	 Pale Eucalypt[®] 84221 Satin 36648 Matt	 Wilderness[®] 84224 Satin 52027 Matt
 Plantation[™] 88378 Satin	 Cottage Green[™] 84219 Satin 52037 Matt	 Dune[™] 84763 Satin 84764 Matt	 Bushland[™] 88379 Satin
 Woodland Grey[®] 84220 Satin 51698 Matt	 Blue Ridge[™] 88480 Satin	 Deep Ocean[®] 83249 Satin 84713 Matt	 Surfmist[™] 84608 Satin 84758 Matt
 Shale Grey[™] 83246 Satin 84711 Matt	 Windspray[™] 84760 Satin 85042 Matt	 Ironstone[™] 88481 Satin	 Night Sky[™] 19268 Satin 84702 Matt

18.006.014 LUX FAA P/COATING COLOUR CARD. NOTE: Colours are as close as printing process will allow. ©2010 Registered Trade Mark of Hunter Douglas Limited (ABN 98 009 675 109).
#Registered Trade Marks of Dulux Australia a Division of Orica Australia Pty Ltd ABN 99 00 411 7828 *Dulux Australia a Division of Orica Australia Pty Ltd has applied for the registration of this trade mark.



LUXAFLEX®

WINDOW FASHIONS

